

Article number: 20240828530GG

Description: E+G Telescope-Lear motion bearings GN 2408-28-530-GG

Measures

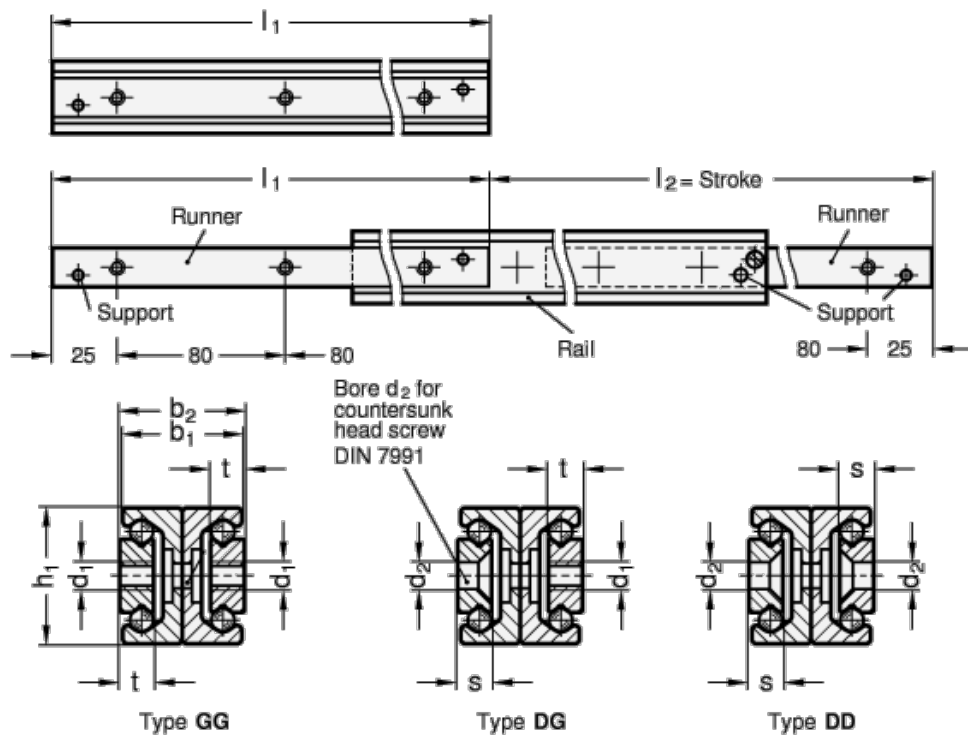

$b_1 = 24.6$

$b_2 = 25.8$

$d_1 = M5$

$d_2 =$

$h_1 = 28$

$L_1 = 530 - 548$

$s =$

$t = 7$

Weight in (g) = 2230